

# Spa

Bathroom Lighting

## Cali Adjustable Downlight

35723, 35724, 35725, 35726, 35727- v3

Please take time to read this leaflet carefully and retain it for future reference.



This product should be disposed of responsibly at the end of its life. Please recycle where facilities exist. Check with your Local Authority or retailer for recycling advice (Waste Electrical and Electronic Equipment Directive)

### Safety First!

Light fittings should be connected to a 5 amp fused circuit.

This light fitting is suitable for indoor use only. It should not be fitted to newly painted or plastered surfaces as this may cause discolouration of the finish.

### Important!

This light fitting is double insulated and must not be earthed.

Do not attach any part of it to an earth wire or terminal.

There must be at least 150mm Air Gap behind the mounting surface.

The minimum distance between the lamp and illuminated objects should be 0.2m.



If in doubt, consult a qualified electrician.

### Warning!

Before commencing installation, isolate the circuit to be used by removing the fuse or circuit breaker at the consumer distribution unit.

### Step 1

Determine the desired position of each downlight. Cut circular holes 75mm in diameter at the required positions ensuring there are no hidden pipes or electrical cables behind the mounting surface. Take care not to exceed the cutout diameter.

### Step 2

To assemble each downlight insert the terminal support into one of the retaining clips as shown.

### Step 3

Unscrew the retaining screws and remove the terminal block covers.

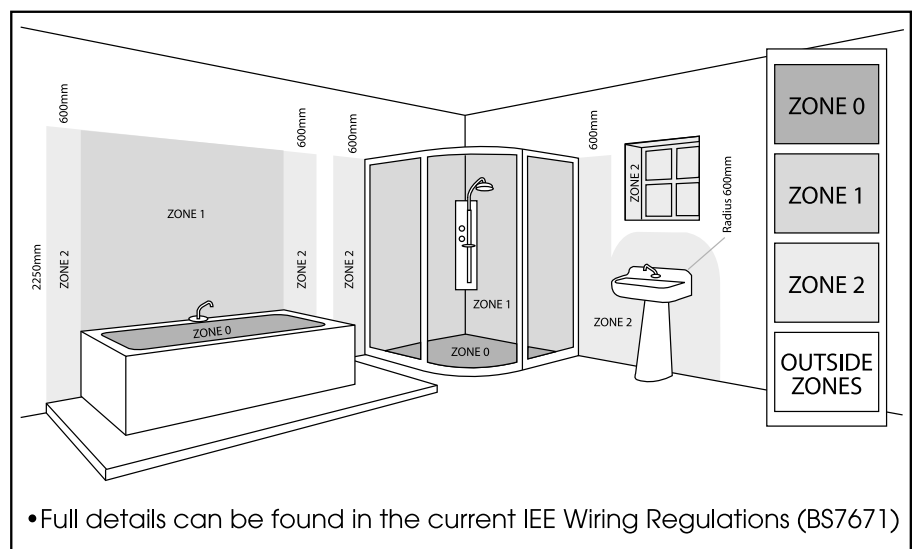
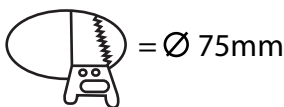
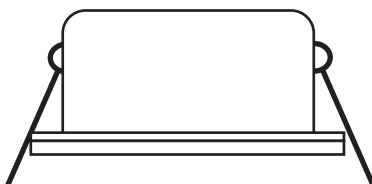
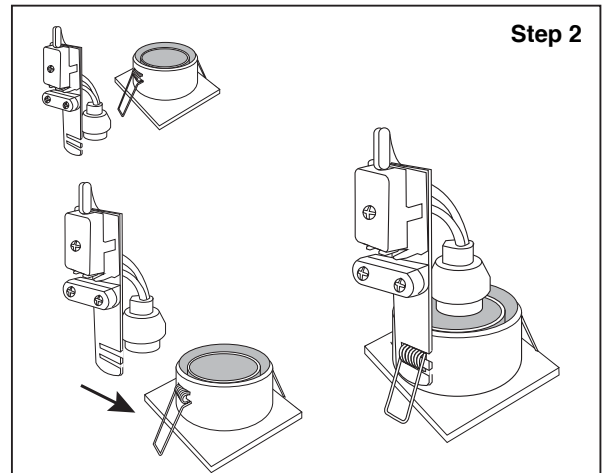

This product is rated IP65 and is suitable for installation in ZONE 2 and the area marked (DRY) OUTSIDE ZONES.

It can also be installed in ZONE 1 if connected to a 30mA RCD protected circuit.

#### Step 4

Using the connector block supplied, connect the wires in the following way:

#### Supply

NEUTRAL  
BLUE OR BLACK

SWITCHED LIVE

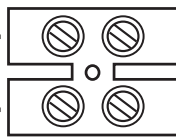

#### Light Fitting

Marked (N)

Marked (L)

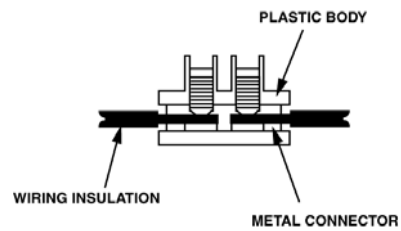

#### Check that.....

You have correctly identified the house wires, the connections are tight and no loose strands have been left out of the connection block.

#### Step 5

Replace the terminal block covers and tighten the retaining screws.

#### Step 6

To insert the downlights into the ceiling:

- A - Angle the light so that the connector block can be inserted through the hole.
- B - Offer the light up to the hole, so that the retaining clips catch on the ceiling as shown.
- C - Gently push the light into the hole so that the clips lock the light into position

Ensure any supply wiring is clear of the rear of the bulbs.

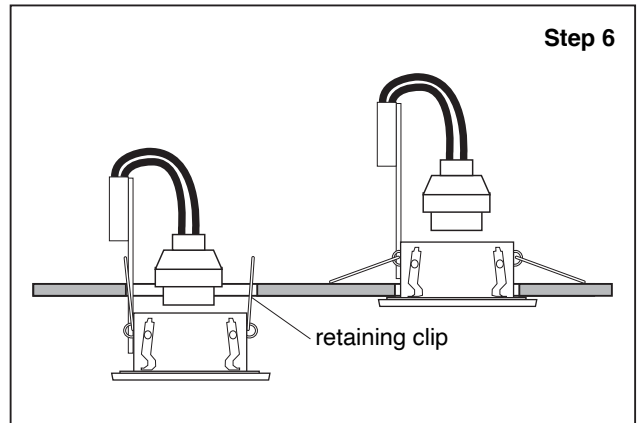

#### Step 7

##### Fitting the Lightbulb

1. Remove the Glass cover from the downlight.
2. Pull the lampholder out of the downlight.
3. Insert the Bulb into the lampholder.
4. Push the bulb / lampholder into the downlight.
5. Push the Glass cover onto the downlight.

##### Selecting the correct lightbulb

Maximum wattage - 35 Watts.

Lightbulb shape - reflector.

Lightbulb cap shape - GU10.

Self shielded – identified by this symbol



Do not exceed the maximum wattage or use a different shape of lightbulb. This may cause your light fitting to overheat.

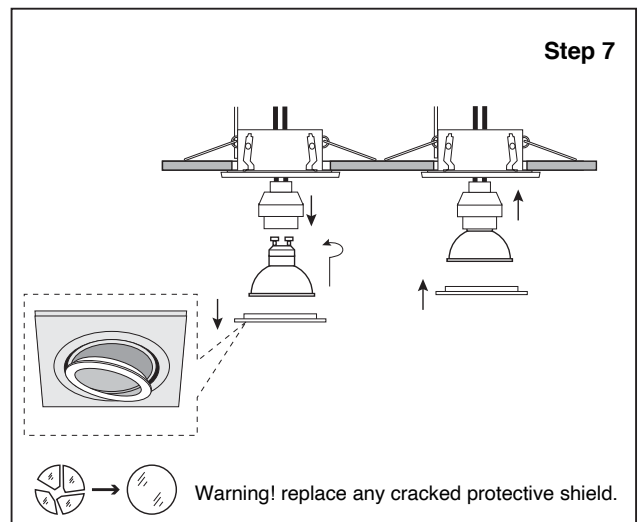

##### Method of Adjustment

The downlight is mounted on 2 rotating joints so that the direction of illumination can be altered by pressing on the cover.

By gently rotating the downlight in its mounting hole, this can allow the light to shine on specific areas.

**Please note: do not over rotate the full light as this can put pressure on the wiring connection.**

##### Switch on!

You may now switch the electricity back on. We are sure you will be pleased with your new light fitting and that it will give you many years of trouble-free enjoyment.

##### Cleaning care

We recommend cleaning with a soft dry cloth. Don't use abrasive materials as these will rub away the protective coating.

##### Safety information

For your safety, please remember the following:

Always switch off the supply before changing lightbulbs or cleaning.

##### Helpline

If you receive this item with parts broken or missing, please telephone: **0333 0050077** Please have ready your name, address, tel. no., product reference, where purchased and parts required. An answering service is in operation outside office hours and during busy periods. **We regret that we are unable to give advice on internal house wiring.**

Cascade Holdings Ltd, Gorse Mill, Gorse Street, Chadderton, Oldham. OL9 9RJ

EU Authorised Representative: Authorised Rep Compliance,

Ground Floor, 71 Lower Baggot Street, Dublin, Ireland,

D02P593.

