

## KonnektIT 204 CL / Single PC

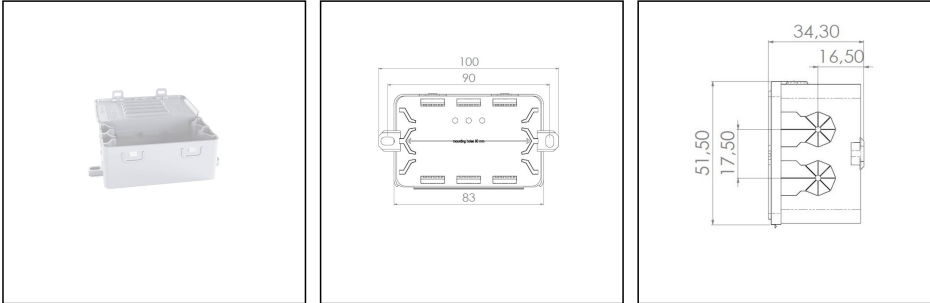

Products may differ in size, colour and appearance to those shown. If you require further information or customisation, please contact us directly.

<b>Material</b>	Polypropylene
<b>Protection class</b>	IP20
<b>Temp. range min</b>	-30 °C
<b>Temp. range max</b>	60 °C
<b>Temperatures during install.</b>	-5 °C - 60 °C
<b>Glow wire test</b>	750 °C
<b>Voltage</b>	400 V
<b>Rated cross section</b>	1,5 mm <sup>2</sup>
<b>Fixing</b>	2 external mounting feet
<b>External dimensions LxWxH</b>	100 x 51,5 x 34 mm
<b>Product Color</b>	transparent
<b>WISKA-Order no.</b>	10112454
<b>Type</b>	KonnektIT 204 CL / Single PC
<b>Packing unit</b>	1
<b>Tariff number</b>	39269097
<b>ETIM-Classification</b>	EC002600

29.04.2024

Your Contact:

**WISKA UK Ltd.**

Unit 7, Hurling Way · St. Columb Major Business Park · TR9 6SX, St. Columb Major, Cornwall · Great Britain

☎ +44-12-08816062 · 📠 +44-12-08816708

info@wiska.co.uk · www.wiska.co.uk

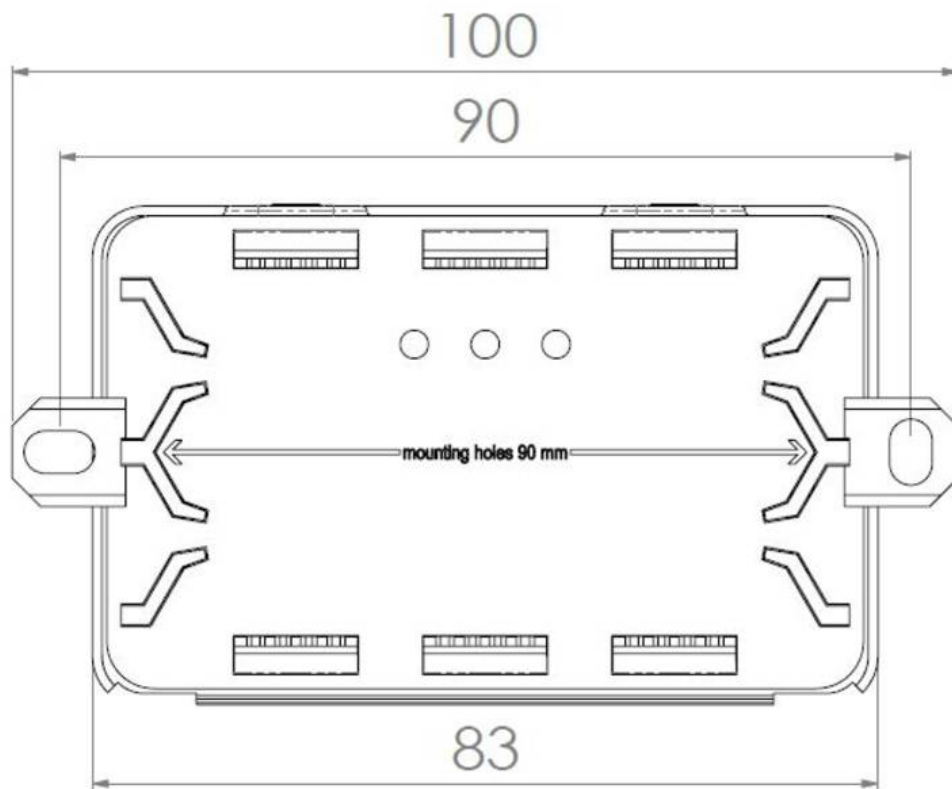

Your Contact:

**WISKA UK Ltd.**

Unit 7, Hurling Way · St. Columb Major Business Park · TR9 6SX, St. Columb Major, Cornwall · Great Britain

☎ +44-12-08816062 · 📠 +44-12-08816708

info@wiska.co.uk · www.wiska.co.uk

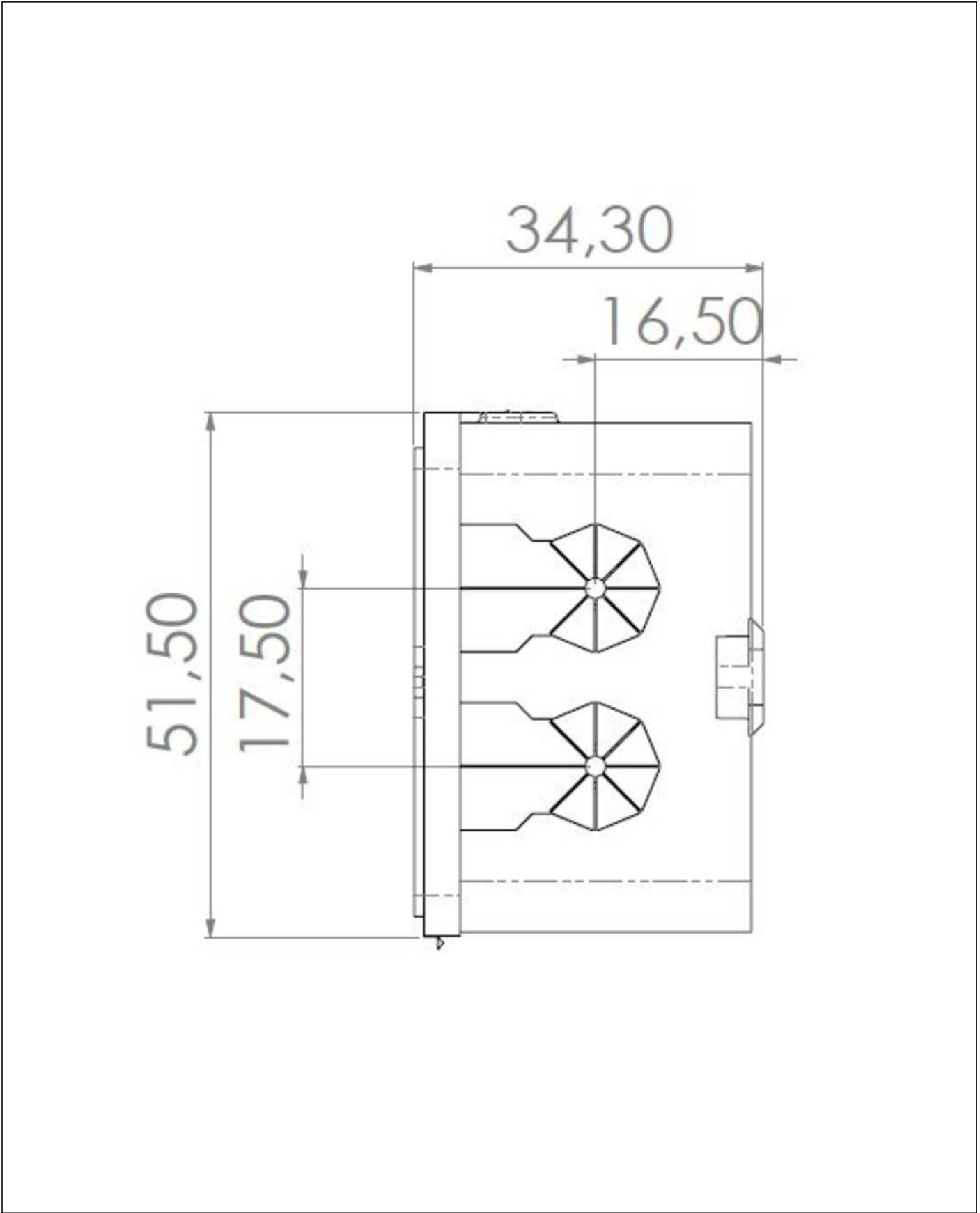

Your Contact:

**WISKA UK Ltd.**

Unit 7, Hurling Way · St. Columb Major Business Park · TR9 6SX, St. Columb Major, Cornwall · Great Britain

☎ +44-12-08816062 · 📠 +44-12-08816708

info@wiska.co.uk · www.wiska.co.uk